

Top 100
Global
Innovator
for 10 years

Wiring Devices

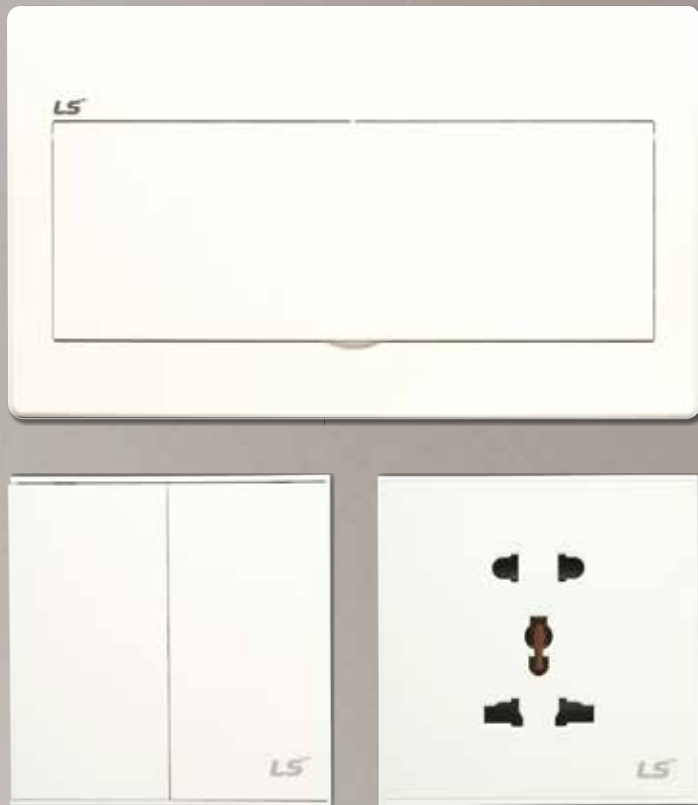

LS[®] **ELECTRIC**

Wiring Devices

Our products have a soft line and a stylish design that makes the interior of the house&Office stand out even more.

- Reliable Mechanism
- Strong Endurance
- Compliance with standards



Socket



Switch



Doorbell switch



Communication socket

Contents

Switch & Socket Series

S series	04-05
G series	06-07
E series	08-09

Spec. & Code

S series	10-11
G series	12-13
E series	14-15

MCB Box	16-19
---------	-------

Project Reference	20-21
-------------------	-------



- Basic & Neat design
- Standard style



1way/2way switch



Control switch



Water heater switch





- Rating : 250V
- Color : white
- 86mm×86mm

Multi socket



Switch socket



Communication socket





- Simple & soft design
- Arc-line with stylish shape



1way/2way switch



Control switch





Multi socket



Switch socket



Communication socket





- Simple & Edge design
- Higher and more unique appearance



1way/2way switch



Control switch





- Rating : 250V
- Color : white
- 86mm×86mm

Multi socket











Switch socket







Communication socket



Wiring Device **S SERIES**

Product Pic.	Description	Model No.
	1 gang 1 way switch	LKS-S 1W1W
	1 gang 2 way switch	LKS-S 1W2W
	16A/250V 10pcs/box 100pcs/ctn 86mm×86mm	
	2 gang 1 way switch	LKS-S 2W1W
	2 gang 2 way switch	LKS-S 2W2W
	16A/250V 10pcs/box 100pcs/ctn 86mm×86mm	
	3 gang 1 way switch	LKS-S 3W1W
	3 gang 2 way switch	LKS-S 3W2W
	16A/250V 10pcs/box 100pcs/ctn 86mm×86mm	
	4 gang 1 way switch	LKS-S 4W1W
	4 gang 2 way switch	LKS-S 4W2W
	16A/250V 10pcs/box 100pcs/ctn 86mm×86mm	
	Voice control	LKS-S W VC
	10A/250V 10pcs/box 100pcs/ctn 86mm×86mm	
	Touch control switch	LKS-S W TC
	10A/250V 10pcs/box 100pcs/ctn 86mm×86mm	
	Dimmer light switch(LED)	LKS-S W DL
	Dimmer fan switch	LKS-S W DF
	1000W/250V 8pcs/box 80pcs/ctn 86mm×86mm	
	Door bell switch	LKS-S W DB
	16A/250V 86mm×86mm	

Product Pic.	Description	Model No.
	2 pole socket	LKS-O 2PW
	10A/250V 10pcs/box 100pcs/ctn 86mm×86mm	
	Double 2pole socket	LKS-O 4PW2W
	10A/250V 10pcs/box 100pcs/ctn 86mm×86mm	
	3 pole multi socket	LKS-O 3PMW
	10A/250V 10pcs/box 100pcs/ctn 86mm×86mm	
	3pole multi socket with switch	LKS-O 3PMW1S
	13A/250V 10pcs/box 100pcs/ctn 86mm×86mm	
	2pole socket with switch	LKS-O 2PW1S
	16A/250V 10pcs/box 100pcs/ctn 86mm×86mm	
	5pole multi 2gang socket	LKS-O 5PMW2W
	10A/250V 10pcs/box 100pcs/ctn 86mm×86mm	
	5pole multi 2gang socket with switch	LKS-O 5PMW2S
	13A/250V 10pcs/box 100pcs/ctn 86mm×86mm	
	3pole multi socket with switch & 2 USB	LKS-O 3PMW1S 2U
	13A/250V 8pcs/box 80pcs/ctn 86mm×86mm	

Product Pic.	Description	Model No.
	TV socket 10pcs/box 100pcs/ctn 86mm×86mm	LKS-C TW
	Computer socket TEL socket 10pcs/box 100pcs/ctn 86mm×86mm	LKS-C NW LKS-C PW
	TV + TEL socket TV + Computer socket 10pcs/box 100pcs/ctn 86mm×86mm	LKS-C TPW LKS-C TNW
	TV + Satellite socket 10pcs/box 100pcs/ctn 86mm×86mm	LKS-C TSW









Product Pic.	Description	Model No.
	2 computer socket TEL + Computer socket 10pcs/box 100pcs/ctn 86mm×86mm	LKS-C NNW LKS-C PNW
	20A water heater switch 20A/250V 10pcs/box 100pcs/ctn 86mm×86mm	LKS-S W 2H
	45A water heater switch 45A/250V 10pcs/box 100pcs/ctn 86mm×86mm	LKS-S W 4H
	Satellite socket 10pcs/box 100pcs/ctn 86mm×86mm	LKS-C SW



Code	Description	Name	Code	Description	Name
06420175W0	LKS-S 1W1W V	1gang1way switch	06430108W0	LKS-O 3PMW V	3pole multi socket
06420176W0	LKS-S 1W2W V	1gang2way switch	06430136W0	LKS-O 3PMW1S V	3pole multi socket with switch
06420177W0	LKS-S 2W1W V	2gang1way switch	06430137W0	LKS-O 4PW2W V	Double 2pole socket
06420178W0	LKS-S 2W2W V	2gang2way switch	06430138W0	LKS-O 2PW1S V	2pole socket with switch
06420179W0	LKS-S 3W1W V	3gang1way switch	06430139W0	LKS-O 5PMW2W V	5pole multi 2gang socket
06420180W0	LKS-S 3W2W V	3gang2way switch	06430140W0	LKS-O 5PMW2SV	5pole multi 2gang socket with switch
06420181W0	LKS-S 4W1W V	4gang1way switch	06430141W0	LKS-O 3PMW1S 2U V	3pole multi socket with switch & 2 USB
06420182W0	LKS-S 4W2W V	4gang2way switch	06440091W0	LKS-C TW V	TV socket
06420183W0	LKS-S W DB V	Door bell switch	06440092W0	LKS-C PW V	Tel socket
06420184W0	LKS-S W DL V	Dimmer light switch	06440093W0	LKS-C NW V	Computer socket
06420185W0	LKS-S W DF V	Dimmer fan switch	06440094W0	LKS-C TPW V	Tel and TV socket
06420186W0	LKS-S W VC V	Voice control switch	06440095W0	LKS-C TNW V	TV and Computer socket
06420187W0	LKS-S W TC V	Touch control switch	06440096W0	LKS-C PNW V	Computer and Tel socket
06420188W0	LKS-S W 2H V	20A Heater water switch	06440097W0	LKS-C NNW V	Double Computer socket
06420189W0	LKS-S W 4H V	45A Heater water switch	06440098W0	LKS-C S V	Satellite socket
06430116W0	LKS-O 6PW 2W V	Double 3 Pole socket	06440099W0	LKS-C TSW V	TV+Satellite socket
06430117W0	LKS-O W SS V	Shaving socket	06420190W0	LKS-E FW V	Water proof cover
06430107W0	LKS-O 2PW V	2pole socket	06420191W0	LKS-S W BP V	Blank plate





Wiring Device **G SERIES**

Product Pic.	Description	Model No.
	1 gang 1 way switch	LKG-S 1W1W
	1 gang 2 way switch	LKG-S 1W2W
	16A/250V 10pcs/box 100pcs/ctn 86mm×86mm	
	2 gang 1 way switch	LKG-S 2W1W
	2 gang 2 way switch	LKG-S 2W2W
	16A/250V 10pcs/box 100pcs/ctn 86mm×86mm	
	3 gang 1 way switch	LKG-S 3W1W
	3 gang 2 way switch	LKG-S 3W2W
	16A/250V 10pcs/box 100pcs/ctn 86mm×86mm	
	4 gang 1 way switch	LKG-S 4W1W
	4 gang 2 way switch	LKG-S 4W2W
	16A/250V 10pcs/box 100pcs/ctn 86mm×86mm	
	Voice control	LKG-S W VC
	10A/250V 10pcs/box 100pcs/ctn 86mm×86mm	
	Touch control switch	LKG-S W TC
	10A/250V 10pcs/box 100pcs/ctn 86mm×86mm	
	Dimmer light switch(LED)	LKG-S W DL
	Dimmer fan switch	LKG-S W DF
	1000W/250V 8pcs/box 80pcs/ctn 86mm×86mm	
	Door bell switch	LKG-S W DB
	16A/250V 86mm×86mm	

Product Pic.	Description	Model No.
	2 pole socket	LKG-O 2PW
	10A/250V 10pcs/box 100pcs/ctn 86mm×86mm	
	Double 2pole socket	LKG-O 4PW2W
	10A/250V 10pcs/box 100pcs/ctn 86mm×86mm	
	3 pole multi socket	LKG-O 3PMW
	10A/250V 10pcs/box 100pcs/ctn 86mm×86mm	
	3pole multi socket with switch	LKG-O 3PMW1S
	13A/250V 10pcs/box 100pcs/ctn 86mm×86mm	
	2pole socket with switch	LKG-O 2PW1S
	16A/250V 10pcs/box 100pcs/ctn 86mm×86mm	
	5pole multi 2gang socket	LKG-O 5PMW2W
	10A/250V 10pcs/box 100pcs/ctn 86mm×86mm	
	5pole multi 2gang socket with switch	LKG-O 5PMW2S
	13A/250V 10pcs/box 100pcs/ctn 86mm×86mm	
	3pole multi socket with switch & 2 USB	LKG-O 3PMW1S 2U
	13A/250V 8pcs/box 80pcs/ctn 86mm×86mm	

Product Pic.	Description	Model No.
	TV socket 10pcs/box 100pcs/ctn 86mm×86mm	LKG-C TW
	Computer socket TEL socket 10pcs/box 100pcs/ctn 86mm×86mm	LKG-C NW LKG-C PW

Product Pic.	Description	Model No.
	TV + TEL socket TV + Computer socket 10pcs/box 100pcs/ctn 86mm×86mm	LKG-C TPW LKG-C TNW
	2 computer socket TEL + Computer socket 10pcs/box 100pcs/ctn 86mm×86mm	LKG-C NNW LKG-C PNW



Code	Description	Name
06420162W0	LKG-S 1W1W V	1gang1way switch
06420163W0	LKG-S 1W2W V	1gang2way switch
06420164W0	LKG-S 2W1W V	2gang1way switch
06420165W0	LKG-S 2W2W V	2gang2way switch
06420166W0	LKG-S 3W1W V	3gang1way switch
06420167W0	LKG-S 3W2W V	3gang2way switch
06420168W0	LKG-S 4W1W V	4gang1way switch
06420169W0	LKG-S 4W2W V	4gang2way switch
06420170W0	LKG-S W DB V	Door bell switch
06420171W0	LKG-S W DL V	Dimmer light switch
06420172W0	LKG-S W DF V	Dimmer fan switch
06420173W0	LKG-S W VC V	Voice control switch
06420174W0	LKG-S W TC V	Touch control switch
06430099W0	LKG-O 3PMW V	3pole multi socket
06430130W0	LKG-O 3PMW1S V	3pole multi socket with switch
06430101W0	LKG-O 2PW V	2pole socket
06430131W0	LKG-O 4PW2W V	Double 2pole socket
06430132W0	LKG-O 5PMW2W V	5pole multi 2gang socket
06430133W0	LKG-O 5PMW2S V	5pole multi 2gang socket with switch
06430134W0	LKG-O 2PW1S V	2pole socket with switch
06430135W0	LKG-O 3PMW1S 2U V	3pole multi socket with switch & 2 USB
06440084W0	LKG-C TW V	TV socket
06440085W0	LKG-C PW V	Tel socket
06440086W0	LKG-C NW V	Computer socket
06440087W0	LKG-C TPW V	Tel and TV socket
06440088W0	LKG-C TNW V	TV and Computer socket
06440089W0	LKG-C PNW V	Computer and Tel socket
06440090W0	LKG-C NNW V	Double Computer socket





Wiring Device **E SERIES**

Product Pic.	Description	Model No.
	1 gang 1 way switch	LKE-S 1W1W
	1 gang 2 way switch	LKE-S 1W2W
	16A/250V 10pcs/box 100pcs/ctn 86mm×86mm	
	2 gang 1 way switch	LKE-S 2W1W
	2 gang 2 way switch	LKE-S 2W2W
	16A/250V 10pcs/box 100pcs/ctn 86mm×86mm	
	3 gang 1 way switch	LKE-S 3W1W
	3 gang 2 way switch	LKE-S 3W2W
	16A/250V 10pcs/box 100pcs/ctn 86mm×86mm	
	4 gang 1 way switch	LKE-S 4W1W
	4 gang 2 way switch	LKE-S 4W2W
	16A/250V 10pcs/box 100pcs/ctn 86mm×86mm	
	Voice control	LKE-S W VC
	10A/250V 10pcs/box 100pcs/ctn 86mm×86mm	
	Touch control switch	LKE-S W TC
	10A/250V 10pcs/box 100pcs/ctn 86mm×86mm	
	Dimmer light switch(LED)	LKE-S W DL
	Dimmer fan switch	LKE-S W DF
	1000W/250V 8pcs/box 80pcs/ctn 86mm×86mm	
	Door bell switch	LKE-S W DB
	16A/250V 86mm×86mm	

Product Pic.	Description	Model No.
	2 pole socket	LKE-O 2PW
	10A/250V 10pcs/box 100pcs/ctn 86mm×86mm	
	Double 2pole socket	LKE-O 4PW2W
	10A/250V 10pcs/box 100pcs/ctn 86mm×86mm	
	3 pole multi socket	LKE-O 3PMW
	10A/250V 10pcs/box 100pcs/ctn 86mm×86mm	
	3pole multi socket with switch	LKE-O 3PMW1S
	13A/250V 10pcs/box 100pcs/ctn 86mm×86mm	
	2pole socket with switch	LKE-O 2PW1S
	16A/250V 10pcs/box 100pcs/ctn 86mm×86mm	
	5pole multi 2gang socket	LKE-O 5PMW2W
	10A/250V 10pcs/box 100pcs/ctn 86mm×86mm	
	5pole multi 2gang socket with switch	LKE-O 5PMW2S
	13A/250V 10pcs/box 100pcs/ctn 86mm×86mm	
	3pole multi socket with switch & 2 USB	LKE-O 3PMW1S 2U
	13A/250V 8pcs/box 80pcs/ctn 86mm×86mm	

Product Pic.	Description	Model No.
	TV socket 10pcs/box 100pcs/ctn 86mm×86mm	LKE-C TW
	Computer socket TEL socket 10pcs/box 100pcs/ctn 86mm×86mm	LKE-C NW LKE-C PW

Product Pic.	Description	Model No.
	TV + TEL socket TV + Computer socket 10pcs/box 100pcs/ctn 86mm×86mm	LKE-C TPW LKE-C TNW
	2 computer socket TEL + Computer socket 10pcs/box 100pcs/ctn 86mm×86mm	LKE-C NNW LKE-C PNW

Code	Description	Name
06420149W0	LKE-S 1W1W V	1gang1way switch
06420150W0	LKE-S 1W2W V	1gang2way switch
06420151W0	LKE-S 2W1W V	2gang1way switch
06420152W0	LKE-S 2W2W V	2gang2way switch
06420153W0	LKE-S 3W1W V	3gang1way switch
06420154W0	LKE-S 3W2W V	3gang2way switch
06420155W0	LKE-S 4W1W V	4gang1way switch
06420156W0	LKE-S 4W2W V	4gang2way switch
06420157W0	LKE-S W DB V	Door bell switch
06420158W0	LKE-S W DL V	Dimmer light switch
06420159W0	LKE-S W DF V	Dimmer fan switch
06420160W0	LKE-S W VC V	Voice control switch
06420161W0	LKE-S W TC V	Touch control switch
06430091W0	LKE-O 2PW V	2pole socket
06430092W0	LKE-O 3PMW V	3pole multi socket
06430124W0	LKE-O 3PMW1S V	3pole multi socket with switch
06430125W0	LKE-O 4PW2W V	Double 2pole socket
06430126W0	LKE-O 5PMW2S V	5pole multi 2gang socket with switch
06430127W0	LKE-O 5PMW2W V	5pole multi 2gang socket
06430128W0	LKE-O 2PW1S V	2pole socket with switch
06430129W0	LKE-O 3PMW1S 2U V	3pole multi socket with switch & 2 USB
06440077W0	LKE-C TW V	TV socket
06440078W0	LKE-C PW V	Tel socket
06440079W0	LKE-C NW V	Computer socket
06440080W0	LKE-C TPW V	Tel and TV socket
06440081W0	LKE-C TNW V	TV and Computer socket
06440082W0	LKE-C PNW V	Computer and Tel socket
06440083W0	LKE-C NNW V	Double Computer socket





Distribution boards **LSLB**

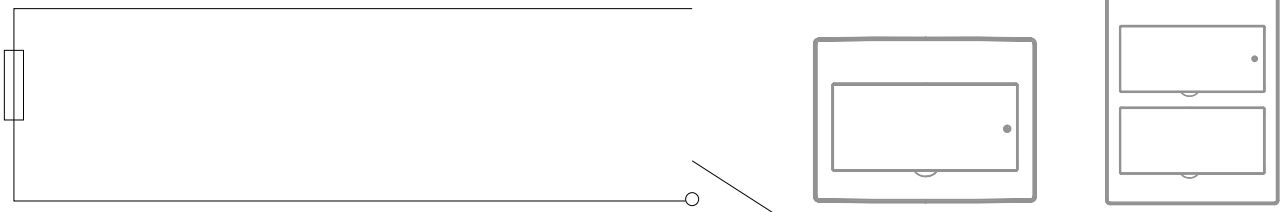

Type		LSLB1	LSLB2
		Transparent	Opaque
Number of branch circuits		4, 8, 12, 16, 20, 24, 28, 32, 36, 40, 48, 60	
Row		1, 2, 3	
Rated insulation voltage	Ui(V)	AC 500V	
Rated frequency	Hz	50/60Hz	
Rated operational voltage	Ue(V)	AC230/400V	
Rated current	In(A)	Up to 125A	
Rated impulse withstand voltage	Uimp(kV)	2.5kV	
Protection grade		IP30	
Temperature	°C	-5°C ~ 60°C	
Installation method		Flush mounting	
Material		Cover : Plastic / Base : Steel	

Dimension

LSLB (Distribution boards)

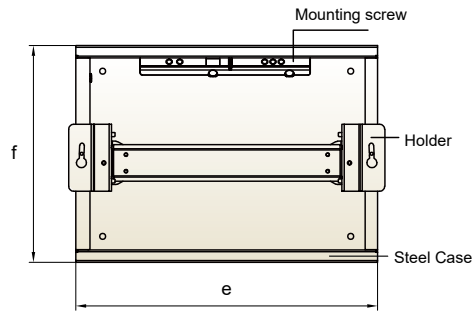
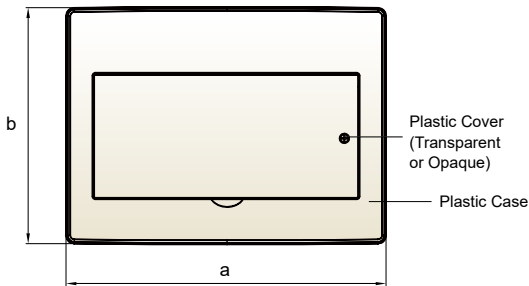

Transparent type

Model name	Row	Number of Branch circuits	Order code	Dimension (mm)					
				a	b	c	d	e	f
LSLB1-104	1	4	50494526006	168	230	104	90	148	210
LSLB1-108	1	8	50494526007	240	230	104	90	220	210
LSLB1-112	1	12	50494526008	312	228	104	90	292	210
LSLB1-116	1	16	50494526009	384	228	104	90	364	210
LSLB1-120	1	20	50494526010	456	228	104	90	436	210

Opaque Type

Model name	Row	Number of Branch circuits	Order code	Dimension (mm)					
				a	b	c	d	e	f
LSLB2-104	1	4	50494526017	168	230	104	90	148	210
LSLB2-108	1	8	50494526018	240	230	104	90	220	210
LSLB2-112	1	12	50494526019	312	228	104	90	292	210
LSLB2-116	1	16	50494526020	384	228	104	90	364	210
LSLB2-120	1	20	50494526022	456	228	104	90	436	210

Dimension

LSLB (Distribution boards)

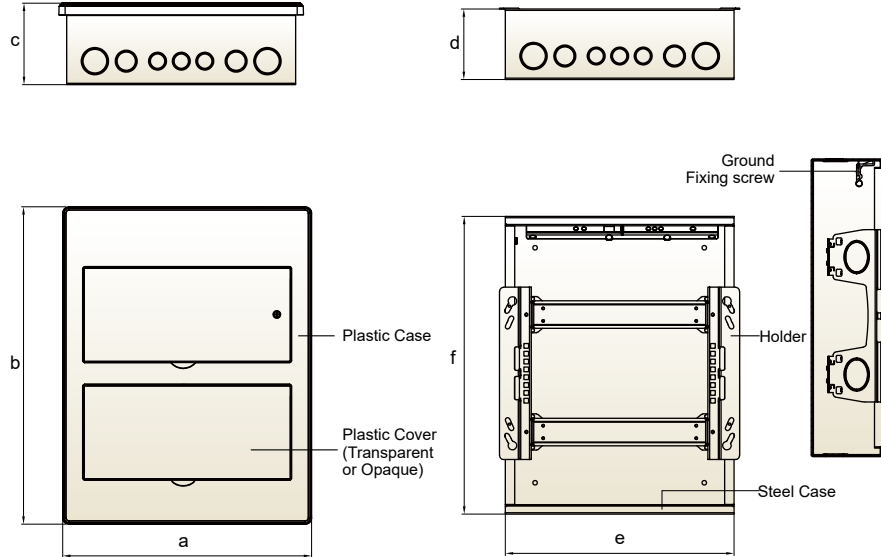

Transparent type

Model name	Row	Number of Branch circuits	Order code	Dimension (mm)					
				a	b	c	d	e	f
LSLB1-224	2	24	50494526011	312	405	104	90	292	380
LSLB1-232	2	32	50494526012	348	405	104	90	364	380
LSLB1-236	2	36	50494526013	420	405	104	90	400	380
LSLB1-240	2	40	50494526014	456	405	104	90	436	380

Opaque Type

Model name	Row	Number of Branch circuits	Order code	Dimension (mm)					
				a	b	c	d	e	f
LSLB2-224	2	24	50494526021	312	405	104	90	292	380
LSLB2-232	2	32	50494526023	348	405	104	90	364	380
LSLB2-236	2	36	50494526024	420	405	104	90	400	380
LSLB2-240	2	40	50494526025	456	405	104	90	436	380

Dimension

LSLB (Distribution boards)

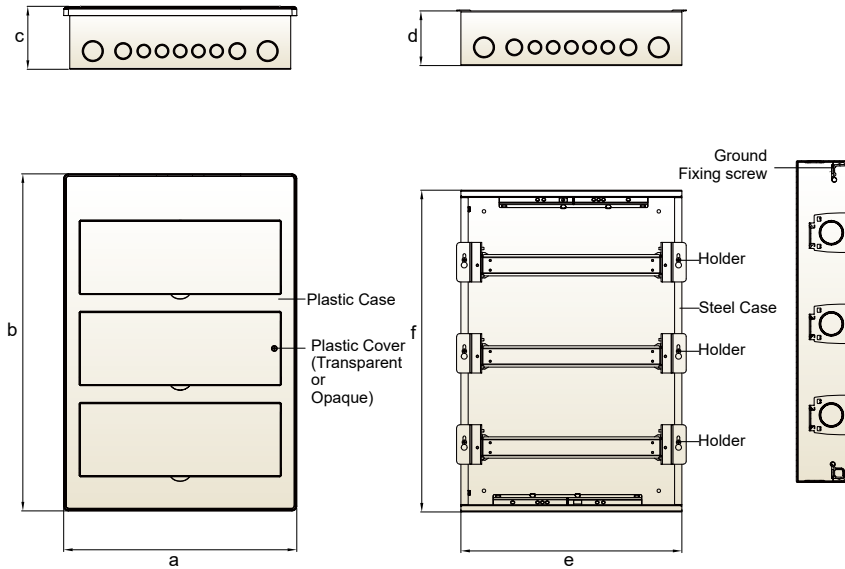

Transparent type

Model name	Row	Number of Branch circuits	Order code	Dimension (mm)					
				a	b	c	d	e	f
LSLB1-348	3	48	50494526015	384	555	104	90	364	530
LSLB1-360	3	60	50494526016	456	555	104	90	436	530

Opaque Type

Model name	Row	Number of Branch circuits	Order code	Dimension (mm)					
				a	b	c	d	e	f
LSLB2-348	3	48	50494526026	384	555	104	90	364	530
LSLB2-360	3	60	50494526027	456	555	104	90	436	530

Project Reference **Southern**



Project SUNRISE CITY NORTH TOWER
Investor NOVALAND



Project THE GALAXY RESIDENCE
Investor NOVALAND



Project LEXINGTON RESIDENCE
Investor NOVALAND



Project THE WILTON RESIDENCE
Investor NOVALAND



Project KRISTA RESIDENCE
Investor CAPITAL LAND



Project THE ART APARTMENT
Investor GIA HOA



Project ORIENTAL PLAZA
Investor PHU THUAN



Project SOUTHERN PEARL APARTMENT
Investor DAI AN



Project MY PHU APARTMENT
Investor PETRO LAND



Project CENTRAL LAND VSIP II
Investor SAI GON LAND OKAMURA-VIETHOME



Project LUCKY DRAGON
Investor NOVALAND



Project THE SILVER STAR
Investor HUNG LOC PHAT

Project Reference **Northern**



Project ARECA BAC GIANG
Investor ARECA VIET NAM & BACH VIET



Project PANDORA TRIEU KHUC
Investor VMC



Project CT6 NAM CUONG
Investor NAM CUONG



Project LEGACY YEN TU
Investor TUNG LAM



Project NEW HORIZON CITY
Investor VINAENCO



Project ECO LAKE VIEW DAI TU
Investor ECOLAND



Project TAY HO STARLAKE
Investor THT



Project ICID LE TRONG TAN
Investor ICID



Safety Instructions

- For your safety, please read user's manual thoroughly before operating.
- Contact the nearest authorized service facility for examination, repair, or adjustment.
- Please contact qualified service technician when you need maintenance. Do not disassemble or repair by yourself!
- Any maintenance and inspection shall be performed by the personnel having expertise concerned.



- According to The WEEE Directive, please do not discard the device with your household waste.



www.ls-electric.com

■ **Headquarter**

LS-ro 127(Hogye-dong) Dongan-gu, Anyang-si, Gyeonggi-Do, 14119, Korea

■ **Seoul Office**

LS Yongsan Tower, 92, Hangang-daero, Yongsan-gu, Seoul, 04386, Korea
Tel: 82-2-2034-4916, 4684, 4429

■ **Overseas Subsidiaries**

- **LS ELECTRIC Japan Co., Ltd. (Tokyo, Japan)**
Tel: 81-3-6268-8241 E-Mail: japan@ls-electric.com
- **LS ELECTRIC (Dalian) Co., Ltd. (Dalian, China)**
Tel: 86-411-8730-5872 E-Mail: china.dalian@lselectric.com.cn
- **LS ELECTRIC (Wuxi) Co., Ltd. (Wuxi, China)**
Tel: 86-510-6851-6666 E-Mail: china.wuxi@lselectric.com.cn
- **LS ELECTRIC Vietnam Co., Ltd. (Hanoi, Vietnam)**
Tel: 84-93-631-4099 E-Mail: vietnam@ls-electric.com
- **LS ELECTRIC Middle East FZE (Dubai, U.A.E.)**
Tel: 971-4-886-5360 E-Mail: middleeast@ls-electric.com
- **LS ELECTRIC Europe B.V. (Hoofddorp, Netherlands)**
Tel: 31-20-654-1424 E-Mail: europartner@ls-electric.com
- **LS ELECTRIC America Inc. (Chicago, USA)**
Tel: 1-800-891-2941 E-Mail: sales.us@lselectricamerica.com
- **LS ENERGY Solutions LLC (Charlotte, USA)**
Tel: 1-704-587-4051 E-Mail: cmfeldman@ls-es.com
- **LS ELECTRIC Turkey Co., Ltd. (Istanbul, Turkey)**
Tel: 90-212-806-1252 E-Mail: turkey@ls-electric.com

■ **Overseas Branches**

- **LS ELECTRIC Tokyo Office (Japan)**
Tel: 81-3-6268-8241 E-Mail: tokyo@ls-electric.com
- **LS ELECTRIC Beijing Office (China)**
Tel: 86-10-5095-1631 E-Mail: china@lselectric.com.cn
- **LS ELECTRIC Shanghai Office (China)**
Tel: 86-21-5237-9977 E-Mail: china@lselectric.com.cn
- **LS ELECTRIC Guangzhou Office (China)**
Tel: 86-20-3818-2883 E-Mail: china@lselectric.com.cn
- **LS ELECTRIC Chengdu Office (China)**
Tel: 86-28-8670-3201 E-Mail: china@lselectric.com.cn
- **LS ELECTRIC Qingdao Office (China)**
Tel: 86-532-8501-2065 E-Mail: china@lselectric.com.cn
- **LS ELECTRIC Nanjing Office (China)**
Tel: 86-25-8467-0005 E-Mail: china@lselectric.com.cn
- **LS ELECTRIC Bangkok Office (Thailand)**
Tel: 66-90-950-9683 E-Mail: thailand@ls-electric.com
- **LS ELECTRIC Jakarta Office (Indonesia)**
Tel: 62-21-2933-7614 E-Mail: indonesia@ls-electric.com
- **LS ELECTRIC Moscow Office (Russia)**
Tel: 7-499-682-6130 E-Mail: info@lselectric-ru.com
- **LS ELECTRIC America Western Office (Irvine, USA)**
Tel: 1-949-333-3140 E-Mail: america@ls-electric.com
- **LS ELECTRIC India Office (India)**
Tel: 91-80-6142-9108 E-Mail: Info_india@ls-electric.com
- **LS ELECTRIC Singapore Office (Singapore)**
Tel: 65-6958-8162 E-Mail: singapore@ls-electric.com
- **LS ELECTRIC Italy office (Italy)**
Tel: 39-030-8081-833 E-Mail: italia@ls-electric.com



Technical Question or After-sales Service

Customer Center-Quick Responsive Service, Excellent technical support

82-1644-5481